

AERO-MOTIVE COMPANY



A Woodhead Industries, Inc. Subsidiary

IMPORTANT SAFETY INSTRUCTIONS

Please read this manual carefully and follow its instructions. Improper use or failure to follow these instructions could result in serious injury, death or property damage. Operators should be instructed in the safe and proper use and maintenance of this product. Keep this manual for future reference.

The following safety precautions call attention to potentially dangerous conditions.



DANGER: Immediate hazards which **WILL** result in severe personal injury or death.



WARNING: Hazards or unsafe practices which **COULD** result in severe personal injury or death.



CAUTION: Hazards or unsafe practices which **MAY** result in *minor* personal injury or product or property damage.

NOTE: Instruct operators in the safe, proper use and maintenance. Keep this manual for future reference.

INSTALLATION



WARNING: Failure to read, understand or follow these instructions could lead to hazards or unsafe practices **COULD** result in severe personal injury or death.



CAUTION: Instruct operators in the safe, proper use and maintenance of this product. Hazards or unsafe practices **MAY** result in *minor* personal injury or product or property damage.

SWIVEL MOUNT

Hang the torque reel in the desired location by clevis provided at top. The torque reel should be suspended directly over the work area (see illustration), using an eyebolt or similar device with a break strength exceeding 6 times the combined weight of torque reel and load it is supporting. Torque reel should be mounted in such a manner as to minimize cable contact with cable guide. For proper alignment, utilize the three (3) mounting holes at top of torque reel. If shackle is removed to make connections, be sure that nut and cotter pin are properly replaced on the shackle pin.

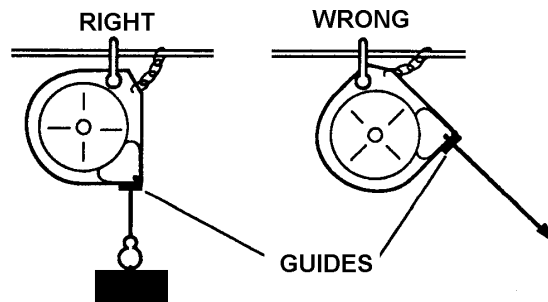

RIDGID MOUNT

Install torque reel in desired location using rigid mount housing. Use housing as a template to drill mounting holes. Mount reel in line with cable pay out to minimize rubbing of cable against cable guide. See illustration.

SECONDARY SUPPORT CHAIN



DANGER: A secondary safety cable or chain is to be attached to all reels mounted overhead to prevent reel from falling. Immediate hazards WILL result in severe personal injury or death.

A hole has been provided at the side of the housing to permit installation of a secondary support chain. All reels mounted over head should have a secondary support chain to protect personnel in case of structure or mounting component failure. Attach one end of secondary support chain or cable to secondary support point on reel. Attach the other end of secondary support chain or cable to a support component other than that which supports the balancer. The chain or cable should be as short as possible allowing the reel to drop no more than 6 to 12 inches if the primary connection is released. (See Illustration On Page 2) A secondary support is offered as an accessory item.

OPERATION

TOOL ATTACHMENT



WARNING: Never pull cable to device to be retracted. Always lift object to hook. If the hook is accidentally released when it is extended, it will snap back. Hazards or unsafe practices COULD result in severe personal injury or death.

If, after installation, it is determined that the overhang of the torque reel for the active travel required is not sufficient, an overhang extension cable can be used to extend the overhang without reducing the active travel. This is available as an optional item. Torque reel is furnished with a tool clip. Attach tool complete with hose or cable and fittings. To adjust length of overhang, remove all tension, then pull down and position hook at desired height. Loosen cable stop, then slide cable stop upward to roller guide and tighten. Move cable stop upward and lengthen overhang of cable to reduce active travel distance. For every foot more of overhang, the active travel will be reduced by a foot.

SPRING TENSION ADJUSTMENT



WARNING: Attach full load including all attachments before adjusting tension. Hazards or unsafe practices COULD result in severe personal injury or death.

The complete tool including all attachments and connections must be in place before adjusting the spring tension. If the load exceeds the spring tension, the tool will move downward. Increase tension of mainspring by applying a wrench on flats of mainspring shaft and rotate counterclockwise until proper tension is reached and load begins to retract. If the tension exceeds the load, the tool will move upward. Spring tension can be decreased by applying a wrench to the flats on mainspring shaft and hold. Release tension of main shaft by squeezing together spring lever slowly on opposite side of torque reel, then rotate wrench clockwise until proper tension is reached and load descends properly. After adjusting tension, pull cable to fullest extension to ensure proper travel is achieved. If cable does not reach full extension, some tension must be released. If proper tension and extension cannot be achieved, consult the factory.

RATCHET LOCK

The ratchet lock works in two positions in one complete rotation. Pull cable to desired location and let cable retract slightly until lock engages. To release lock, pull cable out slightly. For constant tension, ratchet lock may be disengaged. Turn lock release knob counterclockwise while pulling cable in and out slightly to engage lock release lever.

CABLE STOP ADJUSTMENT

NOTE: Moving the cable stop will reduce the active travel distance. If additional cable extension is required, extension cable assemblies (Kit E) are offered as an accessory.

The cable stop can be moved up along the cable to attain the most desirable working height. NOTE: Moving the cable stop will reduce the active travel distance. If additional cable extension is required, extension cable assemblies (Kit E) are offered as an accessory.

SERVICE

MAIN SPRING REPLACEMENT

 **WARNING:** Remove all tension before removing mainspring. Hazards or unsafe practices **COULD** result in severe personal injury or death.

 **WARNING:** Spring is dangerous. Before removing broken spring, weld coils together at four (4) locations or wrap securely with wire. Hazards or unsafe practices **COULD** result in severe personal injury or death.

Remove tension by applying a wrench to the flats on mainspring shaft and **hold**. Release tension of mainshaft by squeezing together spring lever slowly on opposite side of reel. Then rotate wrench clockwise until proper tension is reached and load will descend properly. Remove clevis by removing the cotter pin. Next remove the retaining ring and the three (3) screws, also plates and screws. Remove housing. Remove drum-cover nuts and cover. Carefully remove mainspring from drum.

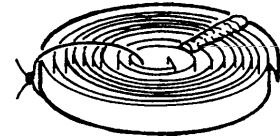

Hub may come off shaft with spring. If so, replace hub into new spring while making sure hub engages spring coils. Replace spring in drum while making sure the spring engages in the lip on drum. To reassemble, reverse the above procedure. Be sure the hub engages the pin on the main shaft when reassembling.

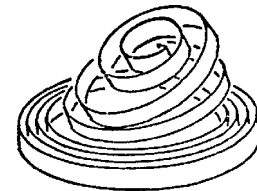

CABLE REPLACEMENT

Whenever a cable shows signs of deterioration, it should be replaced with a new cable. Remove tension by applying a wrench to the flats on mainspring shaft and **hold**. Release tension of mainshaft by squeezing together spring lever slowly on opposite side of reel. Then rotate wrench clockwise until proper tension is reached and load will descend properly. Remove clevis by removing the cotter pin. Next remove the retaining ring and the three (3) screws, also plates and screws. Remove housing. Remove nut and cable. Replace with new cable while threading it through guide first when reassembling.

RATCHET LOCK REPLACEMENT

Remove tension by applying a wrench to the flats on mainspring shaft and **hold**. Release tension of mainshaft by squeezing together spring lever slowly on opposite side of reel. Then rotate wrench clockwise until proper tension is reached and load will descend properly. Remove clevis by removing the cotter pin. Next remove the retaining ring and the three (3) screws, also plates and screws. Remove retaining ring, washer, and spring lock, and retaining ring. The housing can now be removed. Remove retaining ring and unclip spring, then remove ratchet lock. To reassemble, reverse the above procedure.

PARTS REPLACEMENT

 **CAUTION:** Always remove all spring tension (see "Spring Tension Adjustment") before attempting to disassemble internal parts. Always remove balancer from service. Hazards or unsafe practices **MAY** result in *minor* personal injury or product or property damage.

NOTE: When ordering replacement parts, always include the balancer model number and serial number.

All parts are replaceable in the field without special tools.

LUBRICATION

All bearings, springs, etc., are permanently lubricated at the factory and should require no further lubrication.

MAINTENANCE & INSPECTION

Due to the design, this reel will require little maintenance other than a periodic check of the cable and hanger for wear. All worn parts or cable should be removed from service and/or replaced at once.

REPLACEMENT PARTS

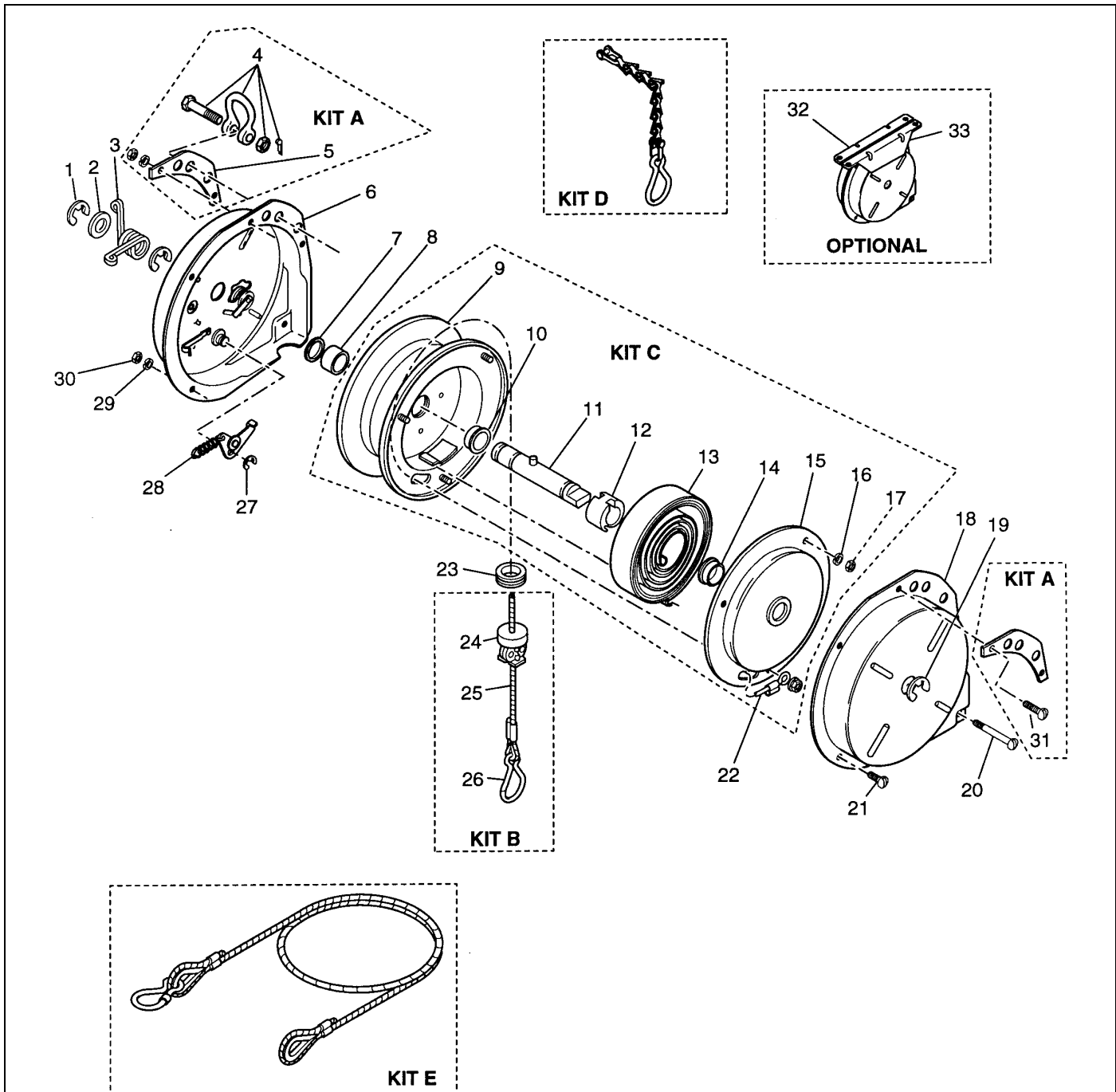

Reference Number	Part Number	Qty.	Description
1	00580P0045	2	Retaining Ring (.625)
2	0981300000	1	Washer
3 *	0961600000	1	Spring tension Lock
4	01240P0010	1	Clevis Assembly (included in Kit A)
5	M62710002	2	Hanger-mounting plate (included in Kit A)
6	0988600000	1	Housing Assembly

7	1409900000	AR	Spacer (used for shim only)
8	0961100000	1	Spacer
9	0967100000	1	Cable drum Assembly (included in Kit C)
10	1361000002	1	Bearing, Main shaft (included in Kit C)
11	0967300000	1	Main shaft (included in Kit C)
12	1405800002	1	Spring hub (included in Kit C)
13 *	0961800239	1	Spring (included in Kit C) 1515T & 1515TR
	0961800030		Spring for model 0515T
	0961800203		Spring for model 1015T
14	1361000001	1	Bearing, Main shaft (included in Kit C)
15	0967100000	1	Cover (included in Kit C)
16	00103P0035	2	Washer, Lock (#8, internal tooth)(included in Kit C)
17	00151P0085	2	Nut (#8 - 32)(included in Kit C)
18	0962100000	1	Housing
19	00580P0035	1	Retaining Ring
20	00002P0114	1	Screw (#8 - 32 x 1 3/4)
21	00002P0101	2	Screw (#8 - 32 x 5/16)
22	00160P0078	1	Locknut (#8 - 32)(included in Kit C)
23	1361300000	1	Cable Guide
24	0983300000	1	Adjustable Cable Stop (included in Kit B)
25 *	0963900015	1	Cable (15 ft.)(included in Kit B)
26	01146P0015	1	Hook (included in Kit B)
27	00058P0030	1	Retaining Ring (.375)
28	H05040010	1	Springs and ratchet kit
29	00103P0035	5	Washer, Lock (#8 internal tooth)
30	00151P0085	5	Nut (#8 - 32)
31	00002P0105	2	Screw (#8 - 32 x 5/8)(included in Kit A)
32	0970100000	A/R	Housing (rigid mount)
33	0973100000	A/R	Housing (rigid mount)

OPTIONAL KITS

Kit A	H16510007		Clevis Kit (includes items 4, 5, 31)
Kit B	0967800015		Cable Assembly (includes items 24, 25, 26)(kit B)
Kit C	0969900239		Mainspring, Drum, & Shaft Assy for 1515T & 1515TR (Includes items 9-17 & 22)
Kit D	4963800000	A/R	Safety Chain
Kit E	4965000001		Cable Overhang (3 ft.)

* Recommended Spare Parts

Aero-Motive Company

W A Woodhead Industries Inc. Subsidiary
PO Box 2678
Kalamazoo, MI 49003-2678
(616) 337 7700
(800) 999 8559
FAX: (800) 333 6119
www.aeromotive.com

AKAPP Electro Industrie

W A Woodhead Industries Inc. Subsidiary
Nijverheidsweg 14 Box 54
NL-3771 ME Barneveld
NL-3771 AB Barneveld
Holland
(31) 34 241 4022
FAX: (31) 34 249 2384
www.akapp.com

Woodhead Connectivity LTD.

W A Woodhead Industries Inc. Subsidiary
Factory No. 9
Rassau Industrial Estate
Ebbw Vale Gwent NP3 5SD
United Kingdom
(0495) 35 0436
FAX: (0495) 35 0877
sales@wdhd.co.uk

Woodhead Asia PTE LTD.

W A Woodhead Industries Inc. Subsidiary
401 Commonwealth Drive #04-04
Haw Par Technocentre
Singapore 0314
(65) 261 6533
FAX: (65) 479 3588
sales@wasia.com.sg

Woodhead Canada LTD.

W A Woodhead Industries Inc. Subsidiary
1090 Brevik Place
Mississauga Ontario
L4W 3Y5 Canada
(905) 624-6518
FAX: (905) 624-9151
www.woodhead.ca